

Dimensions: [mm]

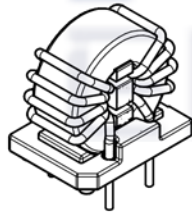

Scale - 1:1

Recommended Hole Pattern: [mm]

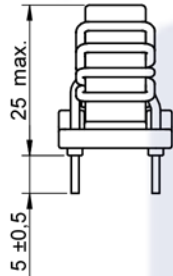
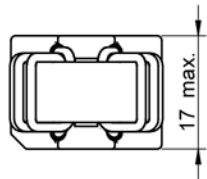
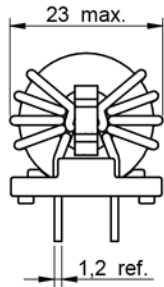
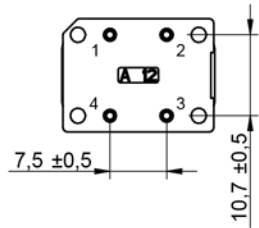
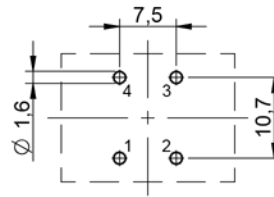

Scale - 1:1

Schematic:



Electrical Properties:

| Properties | Test conditions | | Value | Unit | Tol. |
|-------------------------|---------------------|-----------------|-------|--------|------|
| Inductance | 10 kHz/ 0.1 mA | L | 2x1 | mH | ±50% |
| Rated Current | @ 70 °C | I _R | 15 | A | max. |
| DC Resistance | @ 20 °C | R _{DC} | 2x3.3 | mΩ | max. |
| Rated Voltage | 50 Hz | U _R | 250 | V (AC) | max. |
| Insulation Test Voltage | 50 Hz/ 5 mA/ 2 sec. | U _T | 1500 | V (AC) | |

General Properties:

| | |
|--|----------------------|
| It is recommended that the temperature of the component does not exceed +125°C under worst case conditions | |
| Storage Temperature (in original packaging) | -20 °C up to +60 °C |
| Operating Temperature | -40 °C up to +125 °C |
| Temperature Rise < 55K | |
| Test conditions of Electrical Properties: +20°C, 33% RH if not specified differently | |

Shaanxi FKS Electronic Parts Import&Export Co.,Ltd.
 FKS(Xi'an) Electronic Technology Co.,Ltd.
 Address: B1 Building,Western Cloud Valley,Fengxi New Town,
 Xixian New Area,Xi'an City, Shaanxi Province,China.
 Tel: +86-29-8868 5333
 Fax: +86-29-8868 0913



GENERAL TOLERANCE
DIN ISO 2768-1m

PROJECTION
METHOD

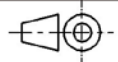

DESCRIPTION
**Common Mode Power
Line Choke Nanocrystalline**

ORDER CODE
FKS7448031501

SIZE
M

REVISION
001.004

STATUS
Valid

Typical Insertion Loss:

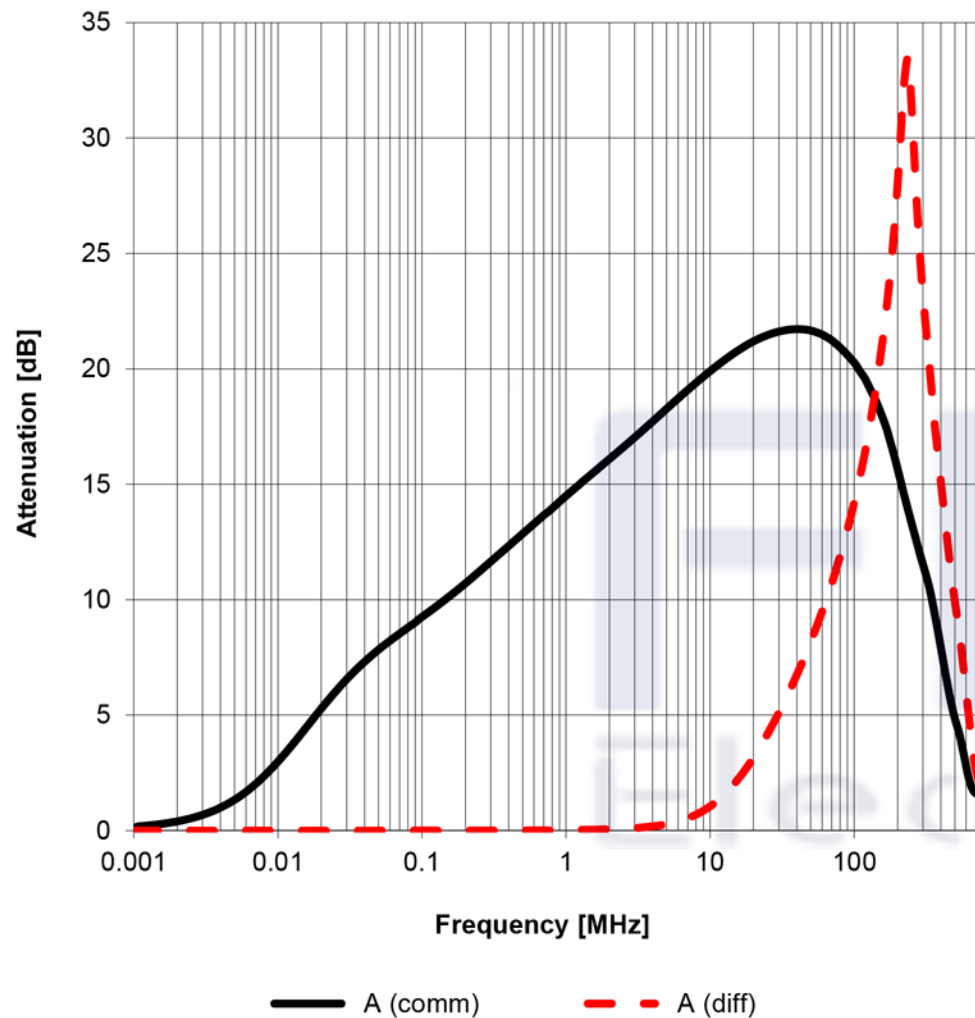

Test Setup:

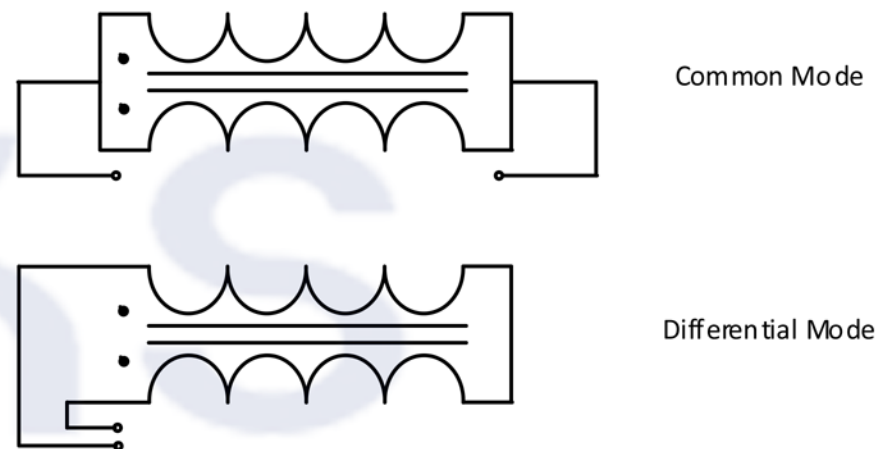

| | | | | | |
|---|---------------------|--------------------------------------|--|-----------------------|--|
| Shaanxi FKS Electronic Parts Import&Export Co.,Ltd. FKS(Xi'an) Electronic Technology Co.,Ltd. Address: B1 Building,Western Cloud Valley,Fengxi New Town, Xixian New Area,Xi'an City, Shaanxi Province,China. Tel: +86-29-8868 5333 Fax: +86-29-8868 0913 | | GENERAL TOLERANCE DIN ISO 2768-1m | | PROJECTION METHOD | |
| DESCRIPTION Common Mode Power Line Choke Nanocrystalline | | ORDER CODE FKS7448031501 | | | |
| SIZE M | REVISION 001.004 | STATUS Valid | | | |

FKS
Electronics



Packaging Specification - Tray and Carton: [mm]

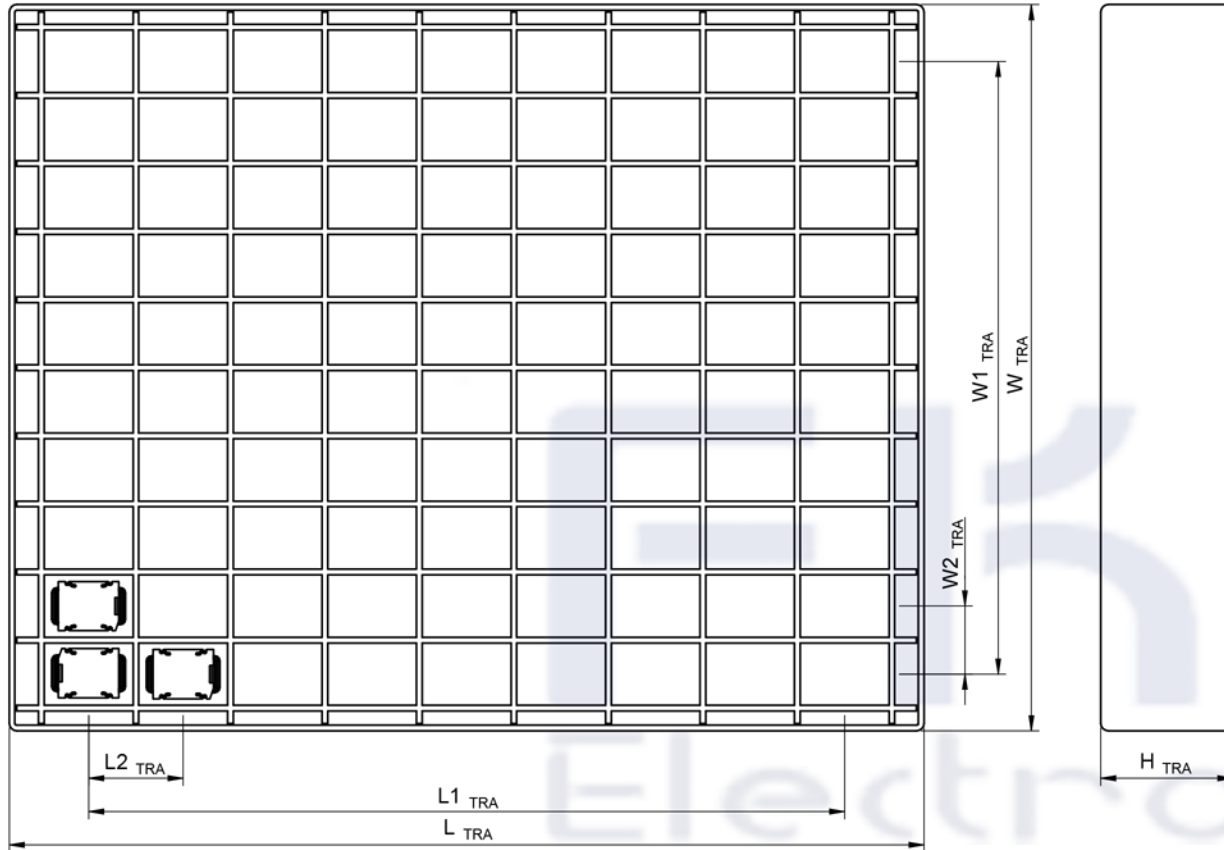

| L _{TRA} (mm) | L1 _{TRA} (mm) | L2 _{TRA} (mm) | W _{TRA} (mm) | W1 _{TRA} (mm) | W2 _{TRA} (mm) | H _{TRA} (mm) | Packaging Unit | Material |
|-----------------------|------------------------|------------------------|-----------------------|------------------------|------------------------|-----------------------|----------------|----------|
| typ. | typ. | typ. | typ. | typ. | typ. | typ. | pcs. | |
| 245,00 | 200,00 | 25,00 | 195,00 | 162,00 | 18,00 | 35,00 | 90 | Paper |

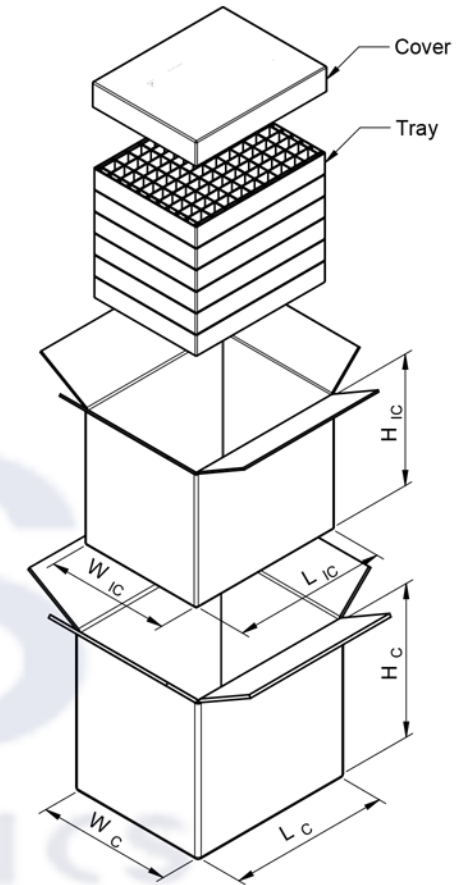

| L _{IC} (mm) | W _{IC} (mm) | H _{IC} (mm) | L _C (mm) | W _C (mm) | H _C (mm) | No. of tray | Packaging Unit | Material |
|----------------------|----------------------|----------------------|---------------------|---------------------|---------------------|-------------|----------------|----------|
| typ. | typ. | typ. | typ. | typ. | typ. | pcs. | pcs. | |
| 260 | 210 | 217 | 275,00 | 232,00 | 255,00 | 6 | 540 | Paper |

Shaanxi FKS Electronic Parts Import&Export Co.,Ltd.
 FKS(Xi'an) Electronic Technology Co.,Ltd.
 Address: B1 Building,Western Cloud Valley,Fengxi New Town,
 Xixian New Area,Xi'an City, Shaanxi Province,China.
 Tel: +86-29-8868 5333
 Fax: +86-29-8868 0913

FKS
Electronics



GENERAL TOLERANCE
DIN ISO 2768-1m

PROJECTION
METHOD



DESCRIPTION
**Common Mode Power
Line Choke Nanocrystalline**

ORDER CODE
FKS7448031501

SIZE
M

REVISION
001.004

STATUS
Valid

Classification Wave Soldering Profile:

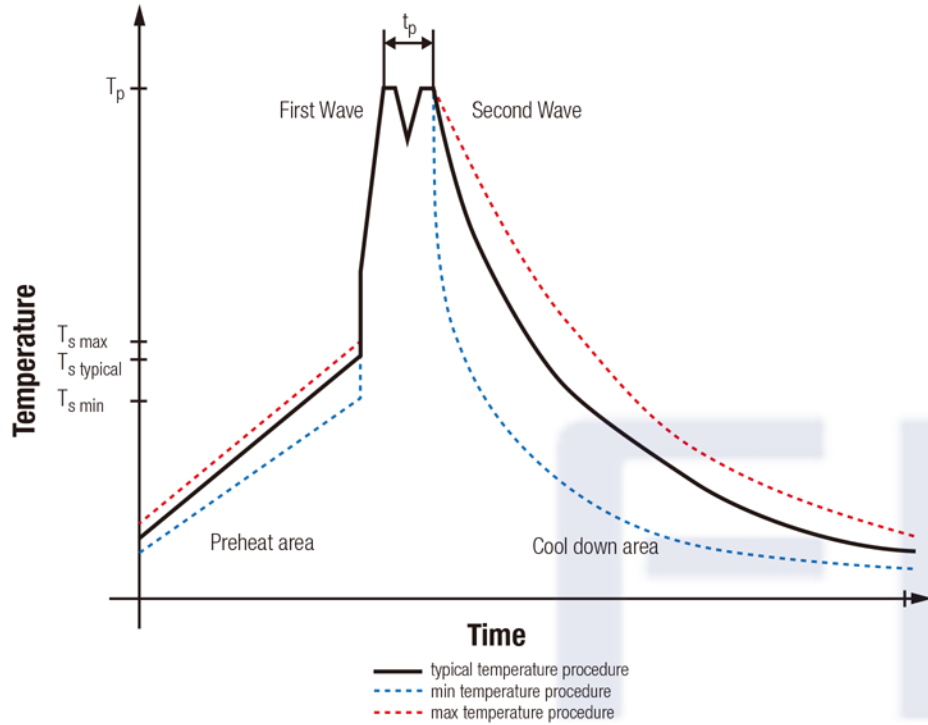

Classification Wave Soldering Profile:

| Profile Feature | | Pb-Free Assembly | Sn-Pb Assembly |
|--|-------------------------|---|---|
| Preheat Temperature Min | $T_{s \min}$ | 100 °C | 100 °C |
| Preheat Temperature Typical | $T_{s \text{ typical}}$ | 120 °C | 120 °C |
| Preheat Temperature Max | $T_{s \max}$ | 130 °C | 130 °C |
| Preheat Time t_s from $T_{s \min}$ to $T_{s \max}$ | t_s | 70 seconds | 70 seconds |
| Ramp-up Rate | ΔT | 150 °C max. | 150 °C max. |
| Peak temperature | T_p | 250 °C - 260 °C | 235 °C - 260 °C |
| Time of actual peak temperature | t_p | max. 10 seconds max. 5 seconds each wave | max. 10 seconds max. 5 seconds each wave |
| Ramp-down Rate, Min | | ~ 2 K/ second | ~ 2 K/ second |
| Ramp-down Rate, Typical | | ~ 3.5 K/ second | ~ 3.5 K/ second |
| Ramp-down Rate, Max | | ~ 5 K/ second | ~ 5 K/ second |
| Time 25°C to 25°C | | 4 minutes | 4 minutes |

refer to EN61760-1:2006

Shaanxi FKS Electronic Parts Import&Export Co.,Ltd.
 FKS(Xi'an) Electronic Technology Co.,Ltd.
 Address: B1 Building,Western Cloud Valley,Fengxi New Town,
 Xixian New Area,Xi'an City, Shaanxi Province,China.
 Tel: +86-29-8868 5333
 Fax: +86-29-8868 0913

FKS
Electronics



GENERAL TOLERANCE
DIN ISO 2768-1m

PROJECTION
METHOD

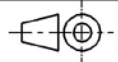

DESCRIPTION
**Common Mode Power
Line Choke Nanocrystalline**

ORDER CODE
FKS7448031501

SIZE
M

REVISION
001.004

STATUS
Valid