

A Dimensions: [mm]

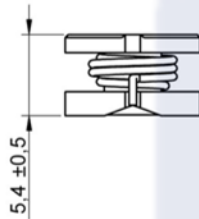
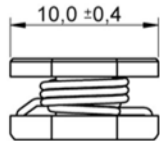
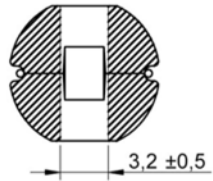

Scale - 2:1

Reference on drawing	Description
•	Start of winding
Marking	330 (Inductance Code)

B Recommended land pattern: [mm]

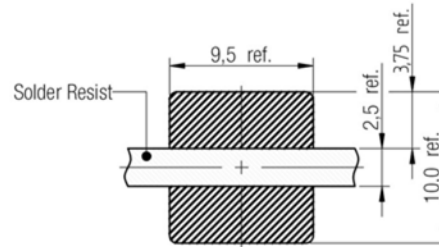

no vias and traces in restricted area

Scale - 2:1

C Schematic:



FKS
Electronics



D Electrical Properties:

Properties	Test conditions		Value	Unit	Tol.
Inductance	10 KHz/ 100 mV	L	33	μH	±10%
Rated Current	ΔT = 40 K	I _R	1.78	A	max.
Saturation Current	ΔL/L < 10%	I _{sat}	1.89	A	typ.
DC Resistance	@ 20°C	R _{DC}	0.12	Ω	max.
DC Resistance	@ 20°C	R _{DC}	0.083	Ω	typ.
Self Resonant Freq.	@ 20°C	f _{res}	12	MHz	typ.
Rated Voltage	@ 20°C	U _R	80	V _{DC}	max.

E General information:

It is recommended that the temperature of the part does not exceed 125°C under worst case operating conditions.

- Ambient temperature: -40°C to +85°C (referring to I_R)
- Operating temperature: -40°C to +125°C
- Storage temperature (on tape & reel): -20°C to +40°C; 75% RH max.
- Coplanarity of the terminal pads: 120μm
- Test conditions of Electrical Properties: 20°C, 33% RH
- AEC-Q 200 qualified



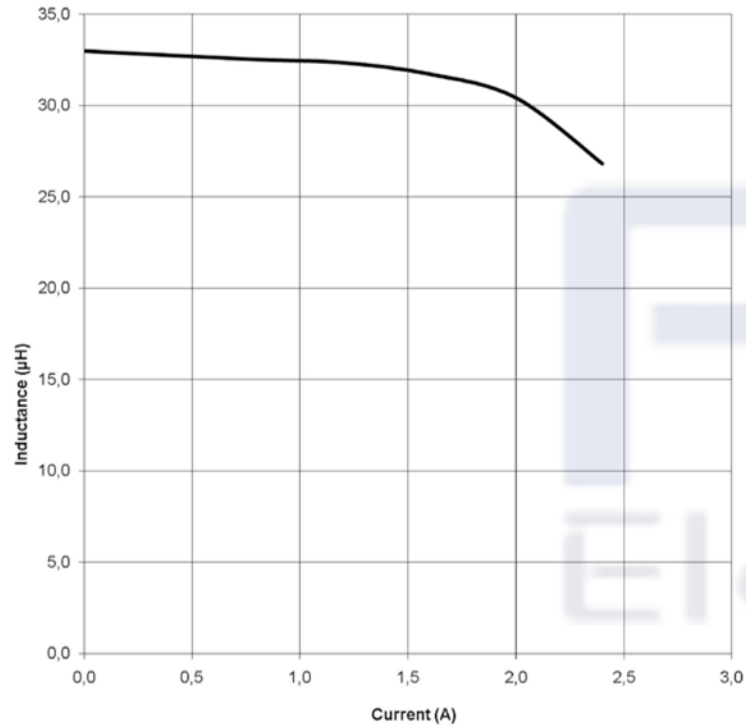

2015-01-07		Projection	DESCRIPTION
			SMD Power Inductor
		Shaanxi FKS Electronic Parts Import&Export Co.,Ltd. FKS(Xi'an) Electronic Technology Co.,Ltd. Address: B1 Building,Western Cloud Valley,Fengxi New Town, Xixian New Area,Xi'an City, Shaanxi Province,China. Tel: +86-29-8868 5333 Fax: +86-29-8868 0913	
DATE		FKS Electronics	Order.- No. FKS-784776133
			COMPLIANT RoHS&REACH
			SIZE A4
			Size: 1054

F1 Typical Inductance vs. Current Characteristics:

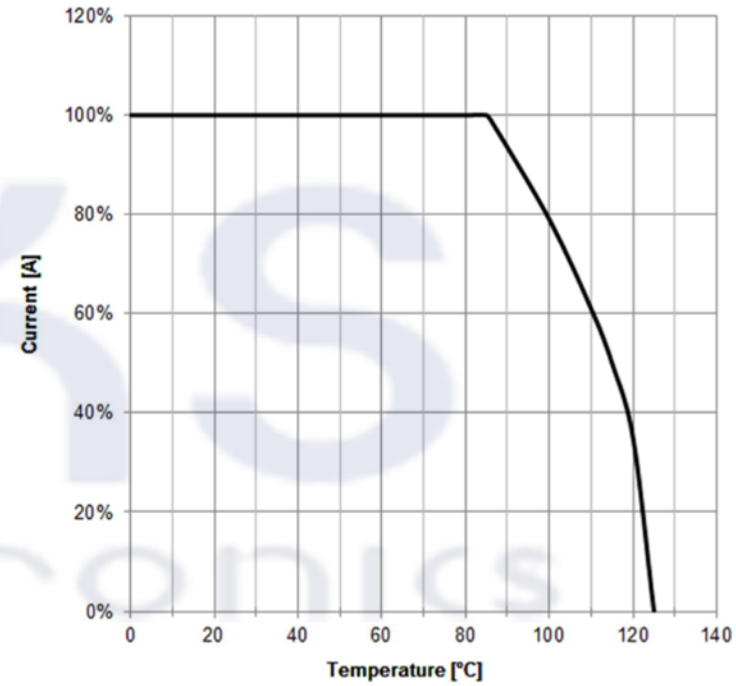

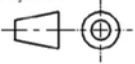

F2 Derating Curve:

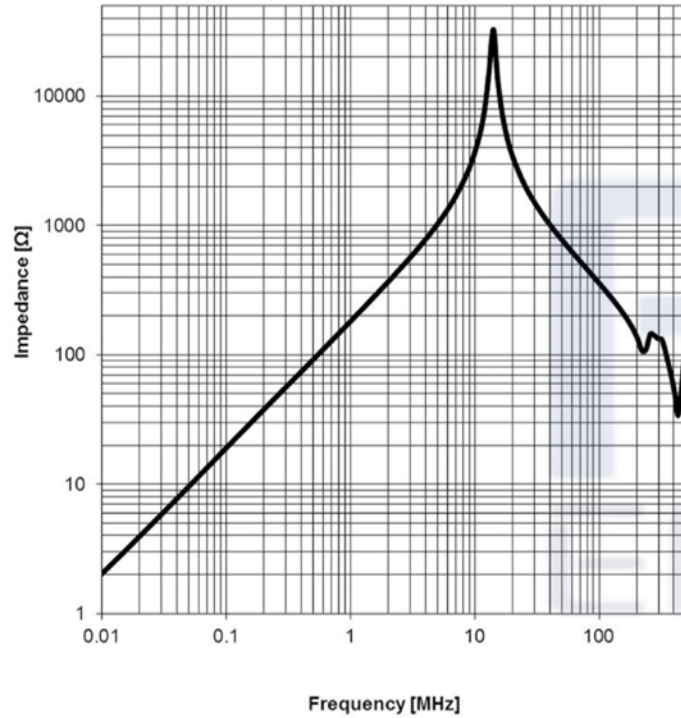

				Projection 		DESCRIPTION	
	2015-01-07					SMD Power Inductor	
				Shaanxi FKS Electronic Parts Import&Export Co.,Ltd. FKS(X'an) Electronic Technology Co.,Ltd. Address: B1 Building,Western Cloud Valley,Fengxi New Town, Xixian New Area,X'an City, Shaanxi Province,China. Tel: +86-29-8868 5333 Fax: +86-29-8868 0913		Order.- No. FKS-784776133	
							SIZE A4
	DATE					Size: 1054	

F3 Typical Impedance Characteristics:

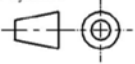

				Projection 		DESCRIPTION		
	2015-01-07					SMD Power Inductor		
				Shaanxi FKS Electronic Parts Import&Export Co.,Ltd. FKS(Xi'an) Electronic Technology Co.,Ltd. Address: B1 Building,Western Cloud Valley,Fengxi New Town, Xixian New Area,Xi'an City, Shaanxi Province,China. Tel: +86-29-8868 5333 Fax: +86-29-8868 0913				Order.- No.
	DATE			 		FKS-784776133		A4
						Size: 1054		

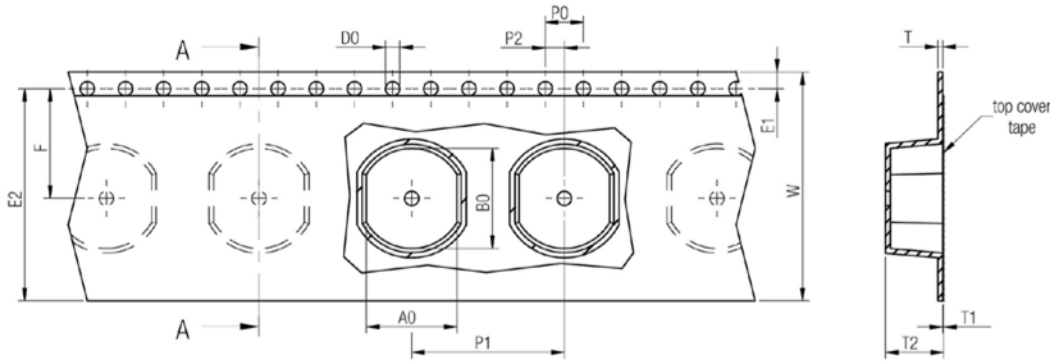

size	A0		B0	W	P1	T	T1	T2	D0	E1	E2	F	P0	P2	VPE / packaging unit
	typ.	typ.	typ.	+0,3 -0,1	± 0,1	± 0,1	max.	typ.	+0,3 -0,1	± 0,1	min.	± 0,05	± 0,1	± 0,05	
4532	4,50	5,50	16,00	8,00	0,25	0,10	4,00	1,50	1,75	14,25	7,50	4,00	2,00	1500	
5848	5,50	6,50	16,00	8,00	0,25	0,10	5,50	1,50	1,75	14,25	7,50	4,00	2,00	1500	
7850	7,50	8,50	16,00	12,00	0,25	0,10	6,00	1,50	1,75	14,25	7,50	4,00	2,00	500	
1054	9,50	10,50	24,00	16,00	0,50	0,10	7,00	1,50	1,75	22,25	11,50	4,00	2,00	500	

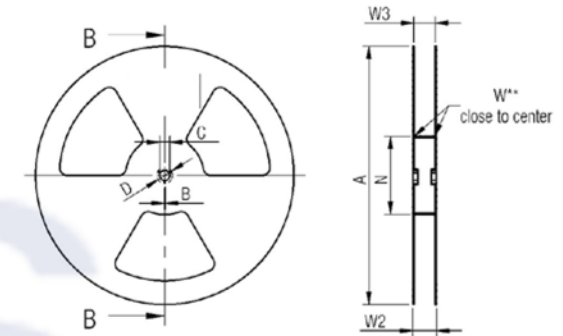

tolerance	A	B	C	D	N	W1	W2	W3	W3
	min.	+ 0,8	min.	min.	+ 1,5	max.	min.	max.	
Tape width 16 mm	330,00	1,50	13,00	20,20	100,00	16,40	22,40	15,90	19,40
Tape width 24 mm	330,00	1,50	13,00	20,20	100,00	24,40	30,40	23,90	27,40

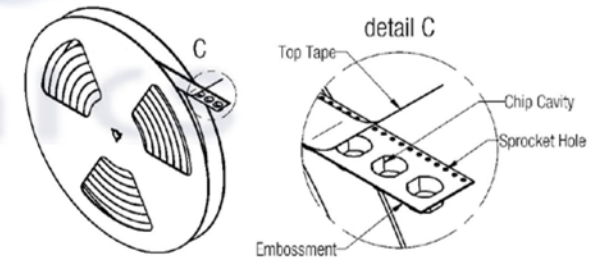
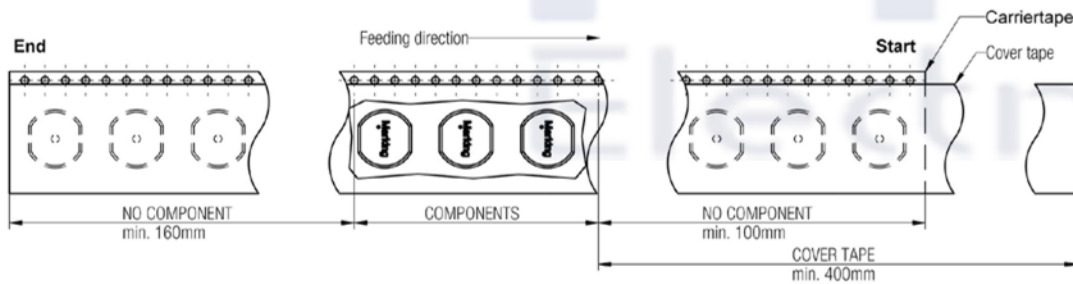

Packaging is referred to the international standard IEC 60286 -3:2007

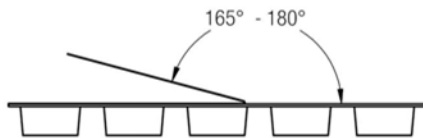

Tape width	Pull-of force	
	16 mm	0,1 N - 1,3 N
24 mm	0,1 N - 1,3 N	

2015-01-07	Projection	DESCRIPTION
		SMD Power Inductor
Shaanxi FKS Electronic Parts Import&Export Co.,Ltd. FKS(Xi'an) Electronic Technology Co.,Ltd. Address: B1 Building,Western Cloud Valley,Fengxi New Town, Xixian New Area,Xi'an City, Shaanxi Province,China. Tel: +86-29-8868 5333 Fax: +86-29-8868 0913		Order.- No. FKS-784776133
DATE		Size: 1054
		SIZE A4

H Soldering Specifications:



H1: Classification Reflow Profile for SMT components:

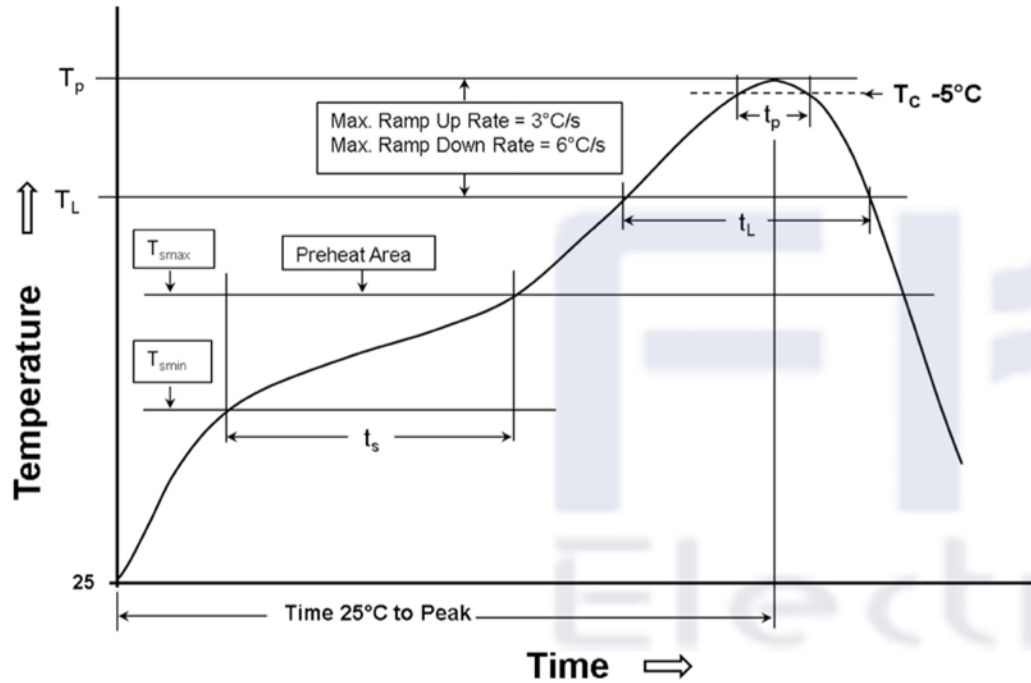

H2: Classification Reflow Profiles

Profile Feature	Pb-Free Assembly	Sn-Pb Assembly
Preheat - Temperature Min (T_{smin}) - Temperature Max (T_{smax}) - Time (t_s) from (T_{smin} to T_{smax})	150°C 200°C 60-120 seconds	100°C 150°C 60-120 seconds
Ramp-up rate (T_L to T_P)	3°C/ second max.	3°C/ second max.
Liquidous temperature (T_L) Time (t_L) maintained above T_L	217°C 60-150 seconds	183°C 60-150 seconds
Peak package body temperature (T_P)	See Table H3	See table H3
Time within 5°C of actual peak temperature (t_p)	30 seconds	20 seconds
Ramp-down rate (T_P to T_L)	6°C/ second max.	6°C/ second max.
Time 25°C to peak temperature	8 minutes max.	6 minutes max.

refer to IPC/JEDEC J-STD-020D

H3: Package Classification Reflow Temperature

	Package Thickness	Volume mm ³ <350	Volume mm ³ >350	Volume mm ³ 350 - 2000	Volume mm ³ >2000
PB-Free Assembly	< 1.6 mm	260°C		260°C	260°C
PB-Free Assembly	1.6 - 2.5 mm	260°C		250°C	245°C
PB-Free Assembly	> 2.5 mm	250°C		245°C	245°C
Sn-Pb Assembly	< 2.5 mm	235°C	220°C		
Sn-Pb Assembly	≥ 2.5 mm	220°C	220°C		

2015-01-07	Projection 	DESCRIPTION SMD Power Inductor
	Shaanxi FKS Electronic Parts Import&Export Co.,Ltd. FKS(Xi'an) Electronic Technology Co.,Ltd. Address: B1 Building,Western Cloud Valley,Fengxi New Town, Xixian New Area,Xi'an City, Shaanxi Province,China. Tel: +86-29-8868 5333 Fax: +86-29-8868 0913 	Order.- No. FKS-784776133
DATE		SIZE A4 Size: 1054