

**A Dimensions: [mm]**

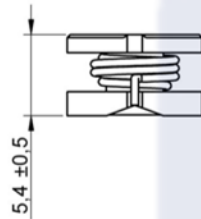
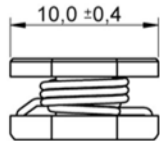
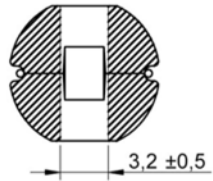

Scale - 2:1

Reference on drawing	Description
•	Start of winding
Marking	470 (Inductance Code)

**B Recommended land pattern: [mm]**

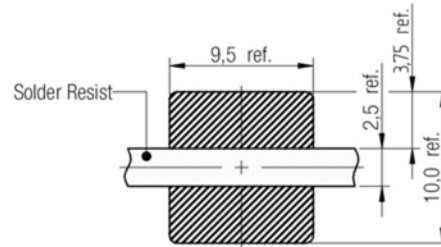

no vias and traces in restricted area

Scale - 2:1

**C Schematic:**



**D Electrical Properties:**

Properties	Test conditions		Value	Unit	Tol.
<b>Inductance</b>	10 KHz/ 100 mV	L	47	μH	±10%
<b>Rated Current</b>	ΔT = 40 K	I <sub>R</sub>	1.45	A	max.
<b>Saturation Current</b>	ΔL/L  < 10%	I <sub>sat</sub>	1.62	A	typ.
<b>DC Resistance</b>	@ 20°C	R <sub>DC</sub>	0.17	Ω	max.
<b>DC Resistance</b>	@ 20°C	R <sub>DC</sub>	0.095	Ω	typ.
<b>Self Resonant Freq.</b>	@ 20°C	f <sub>res</sub>	11	MHz	typ.
<b>Rated Voltage</b>	@ 20°C	U <sub>R</sub>	80	V <sub>DC</sub>	max.

**E General information:**

It is recommended that the temperature of the part does not exceed 125°C under worst case operating conditions.

- Ambient temperature: -40°C to +85°C (referring to I<sub>R</sub>)
- Operating temperature: -40°C to +125°C
- Storage temperature (on tape & reel): -20°C to +40°C; 75% RH max.
- Coplanarity of the terminal pads: 120μm
- Test conditions of Electrical Properties: 20°C, 33% RH
- AEC-Q 200 qualified

2015-01-07	Projection	DESCRIPTION
		<b>SMD Power Inductor</b>
	Shaanxi FKS Electronic Parts Import&Export Co.,Ltd. FKS(Xi'an) Electronic Technology Co.,Ltd. Address: B1 Building,Western Cloud Valley,Fengxi New Town, Xixian New Area,Xi'an City, Shaanxi Province,China. Tel: +86-29-8868 5333 Fax: +86-29-8868 0913	Order.- No. <b>FKS784776147</b>
DATE		SIZE A4
		Size: 1054



F1 Typical Inductance vs. Current Characteristics:

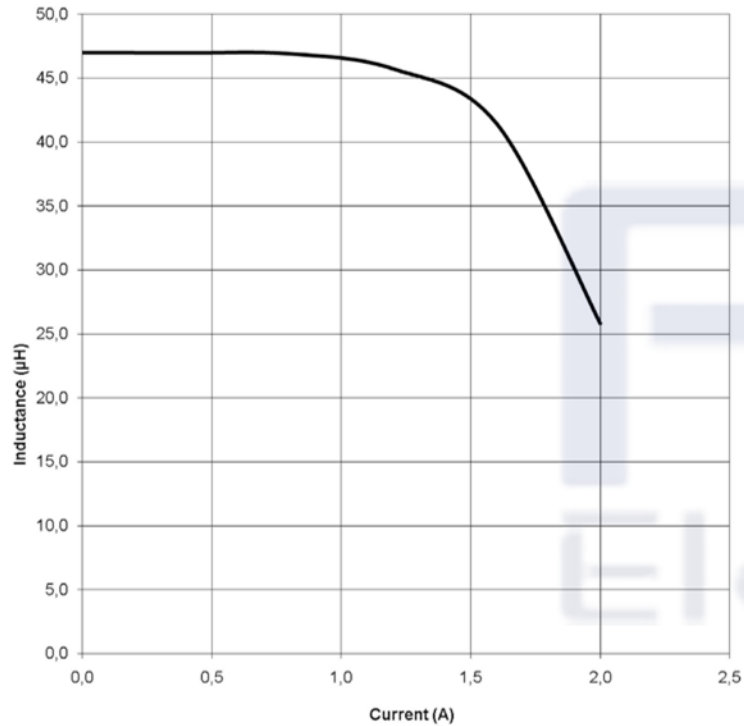



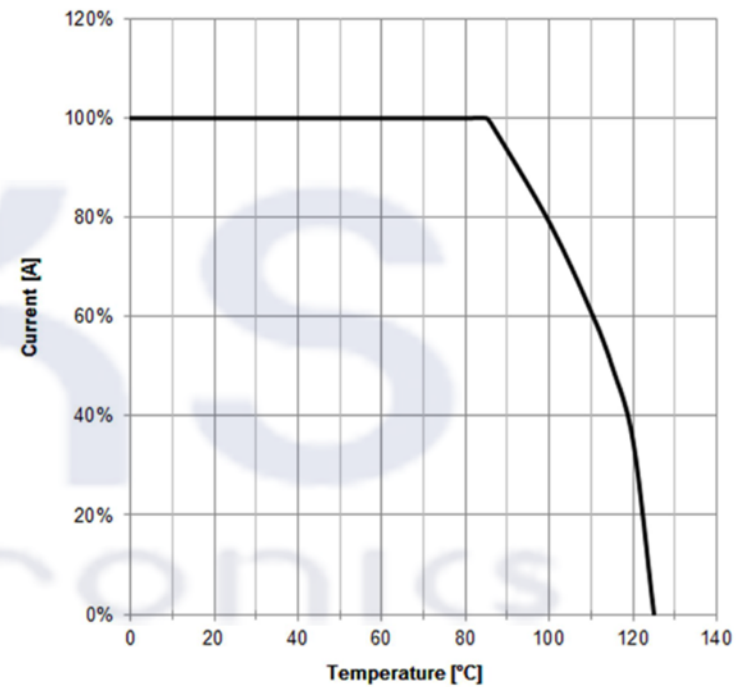

F2 Derating Curve:

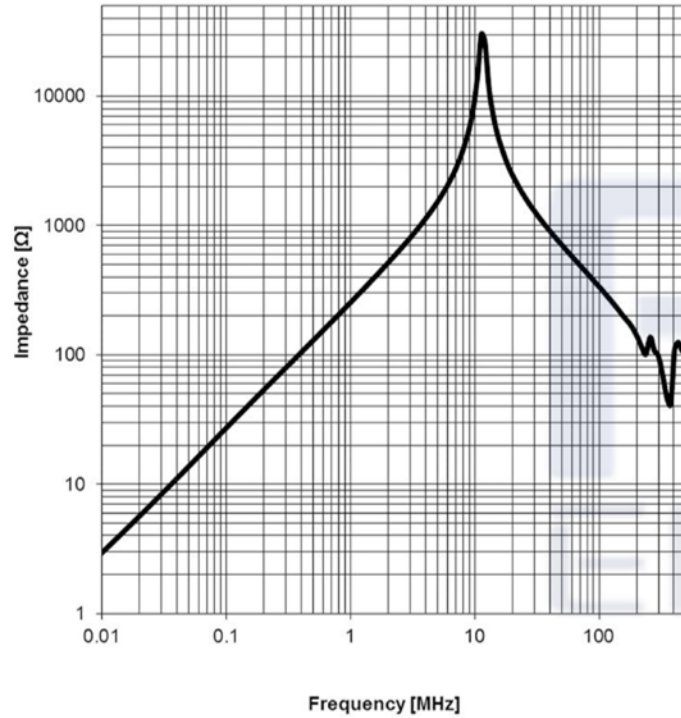

				Projection 		DESCRIPTION
	2015-01-07					<b>SMD Power Inductor</b>
				Shaanxi FKS Electronic Parts Import&Export Co.,Ltd. FKS(Xi'an) Electronic Technology Co.,Ltd. Address: B1 Building,Western Cloud Valley,Fengxi New Town, Xixian New Area,Xi'an City, Shaanxi Province,China. Tel: +86-29-8868 5333 Fax: +86-29-8868 0913		Order.- No. <b>FKS784776147</b>
	DATE					Size: 1054
						SIZE A4

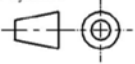
**F3 Typical Impedance Characteristics:**



				Projection 		DESCRIPTION		
	2015-01-07					<b>SMD Power Inductor</b>		
				Shaanxi FKS Electronic Parts Import&Export Co.,Ltd. FKS(Xi'an) Electronic Technology Co.,Ltd. Address: B1 Building,Western Cloud Valley,Fengxi New Town, Xixian New Area,Xi'an City, Shaanxi Province,China. Tel: +86-29-8868 5333 Fax: +86-29-8868 0913		Order.- No.		SIZE
				 		FKS784776147		A4
	DATE					Size: 1054		

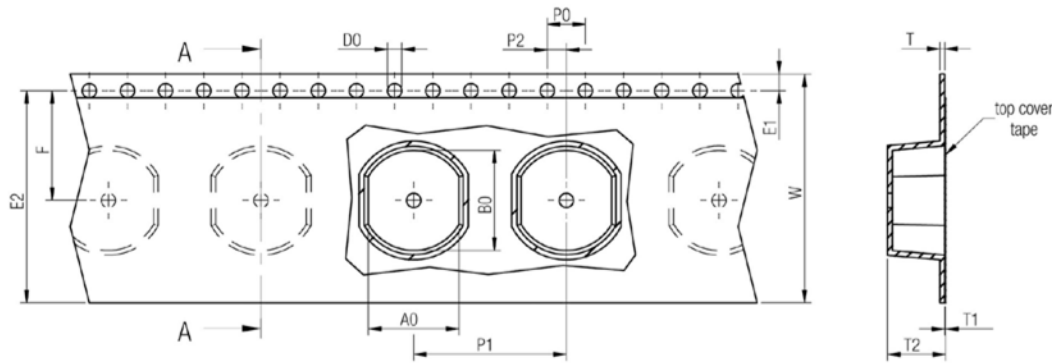

		A0	B0	W	P1	T	T1	T2	D0	E1	E2	F	P0	P2	VPE / packaging unit
tolerance		typ.	typ.	+0,3 -0,1	± 0,1	± 0,1	max.	typ.	+0,3 -0,1	± 0,1	min.	± 0,05	± 0,1	± 0,05	
size	4532	4,50	5,50	16,00	8,00	0,25	0,10	4,00	1,50	1,75	14,25	7,50	4,00	2,00	1500
	5848	5,50	6,50	16,00	8,00	0,25	0,10	5,50	1,50	1,75	14,25	7,50	4,00	2,00	1500
	7850	7,50	8,50	16,00	12,00	0,25	0,10	6,00	1,50	1,75	14,25	7,50	4,00	2,00	500
	1054	9,50	10,50	24,00	16,00	0,50	0,10	7,00	1,50	1,75	22,25	11,50	4,00	2,00	500

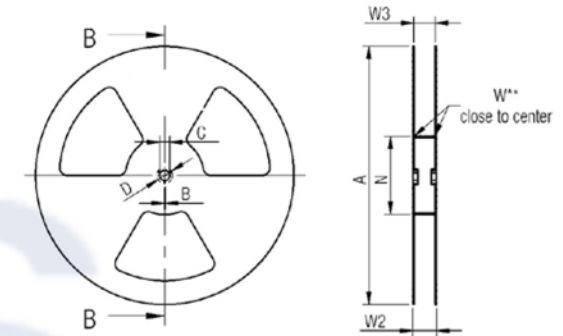

		A	B	C	D	N	W1	W2	W3	W3
tolerance			min.	+ 0,8	min.	min.	+ 1,5	max.	min.	max.
Tape width	16 mm	330,00	1,50	13,00	20,20	100,00	16,40	22,40	15,90	19,40
	24 mm	330,00	1,50	13,00	20,20	100,00	24,40	30,40	23,90	27,40

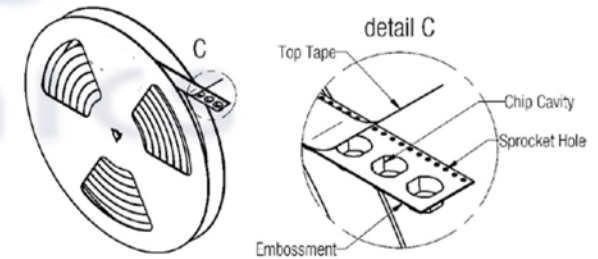
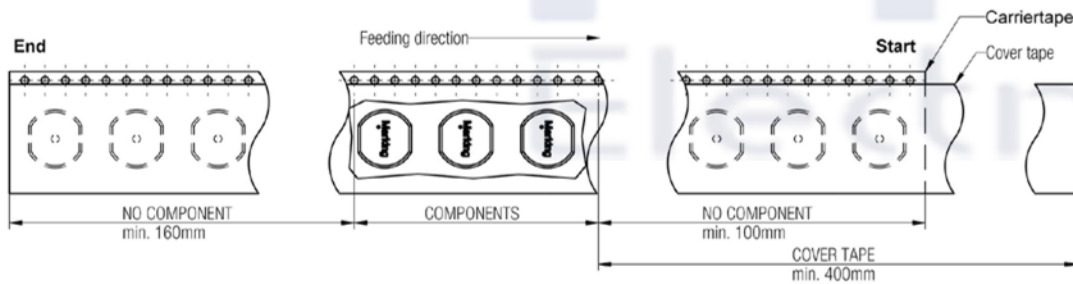

Packaging is referred to the international standard IEC 60286 -3:2007

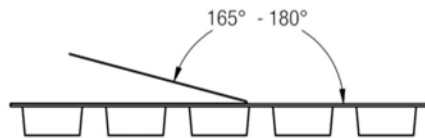

		Pull-of force
Tape width	16 mm	0,1 N - 1,3 N
	24 mm	0,1 N - 1,3 N

2015-01-07	Projection	DESCRIPTION
		<b>SMD Power Inductor</b>
	Shaanxi FKS Electronic Parts Import&Export Co.,Ltd. FKS(Xi'an) Electronic Technology Co.,Ltd. Address: B1 Building,Western Cloud Valley,Fengxi New Town, Xixian New Area,Xi'an City, Shaanxi Province,China. Tel: +86-29-8868 5333 Fax: +86-29-8868 0913	Order.- No. <b>FKS784776147</b>
DATE		Size: 1054
		SIZE A4

H Soldering Specifications:



H1: Classification Reflow Profile for SMT components:

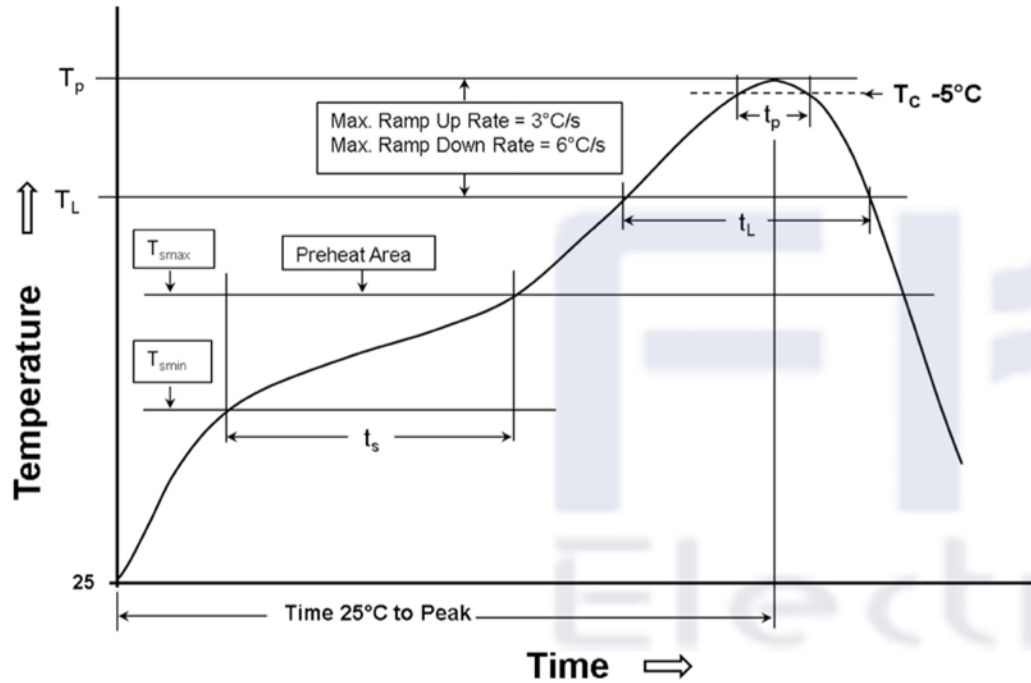

H2: Classification Reflow Profiles

Profile Feature	Pb-Free Assembly	Sn-Pb Assembly
Preheat - Temperature Min ( $T_{smin}$ ) - Temperature Max ( $T_{smax}$ ) - Time ( $t_s$ ) from ( $T_{smin}$ to $T_{smax}$ )	150°C 200°C 60-120 seconds	100°C 150°C 60-120 seconds
Ramp-up rate ( $T_L$ to $T_P$ )	3°C/ second max.	3°C/ second max.
Liquidous temperature ( $T_L$ ) Time ( $t_L$ ) maintained above $T_L$	217°C 60-150 seconds	183°C 60-150 seconds
Peak package body temperature ( $T_P$ )	See Table H3	See table H3
Time within 5°C of actual peak temperature ( $t_p$ )	30 seconds	20 seconds
Ramp-down rate ( $T_P$ to $T_L$ )	6°C/ second max.	6°C/ second max.
Time 25°C to peak temperature	8 minutes max.	6 minutes max.

refer to IPC/JEDEC J-STD-020D

H3: Package Classification Reflow Temperature

	Package Thickness	Volume mm <sup>3</sup> <350	Volume mm <sup>3</sup> >350	Volume mm <sup>3</sup> 350 - 2000	Volume mm <sup>3</sup> >2000
<b>PB-Free Assembly</b>	< 1.6 mm	260°C		260°C	260°C
<b>PB-Free Assembly</b>	1.6 - 2.5 mm	260°C		250°C	245°C
<b>PB-Free Assembly</b>	> 2.5 mm	250°C		245°C	245°C
<b>Sn-Pb Assembly</b>	< 2.5 mm	235°C	220°C		
<b>Sn-Pb Assembly</b>	≥ 2.5 mm	220°C	220°C		

2015-01-07	Projection	DESCRIPTION
		<b>SMD Power Inductor</b>
	Shaanxi FKS Electronic Parts Import&Export Co.,Ltd. FKS(Xi'an) Electronic Technology Co.,Ltd. Address: B1 Building,Western Cloud Valley,Fengxi New Town, Xixian New Area,Xi'an City, Shaanxi Province,China. Tel: +86-29-8868 5333 Fax: +86-29-8868 0913	Order.- No. <b>FKS784776147</b>
DATE		Size: 1054